

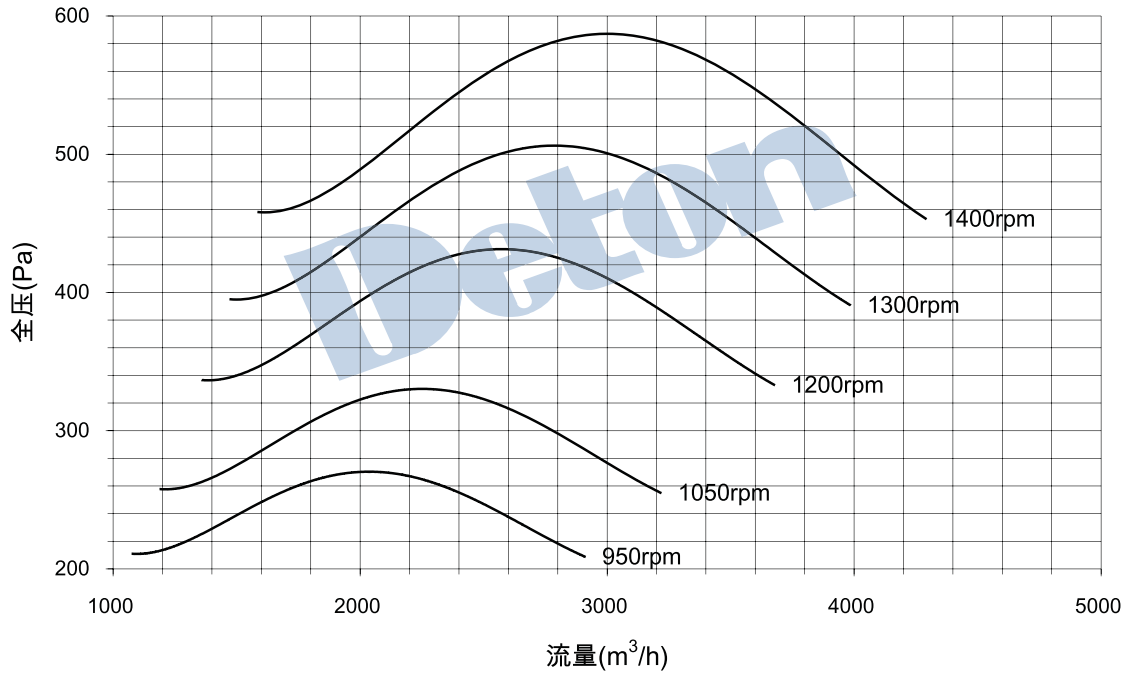

参数实测

DTJ9-I 性能曲线图



DTJ9-I 性能参数表

序号	转速 (r/min)	工况点序号 (No)	风量 (m³/h)	全压 (pa)	静压 (pa)	电机功率 (kW)	电机型号
1	950	1	1710	258	236	0.55	Y80 ₁ -4
		2	1900	268	241		
		3	2153	269	235		
		4	2407	255	212		
		5	2660	232	180		
		6	2913	209	146		
2	1050	1	1890	315	288	0.55	Y80 ₁ -4
		2	2100	327	295		
		3	2380	328	287		
		4	2660	311	259		
		5	2940	283	220		
		6	3220	255	178		
3	1200	1	2160	411	376	0.75	Y80 ₂ -4
		2	2400	428	385		
		3	2720	429	374		
		4	3040	406	338		
		5	3360	370	287		
		6	3680	333	233		
4	1300	1	2340	482	442	1.1	Y90S-4
		2	2600	502	452		
		3	2947	503	439		
		4	3293	477	397		
		5	3640	434	336		
		6	3987	391	273		
5	1400	1	2520	559	512	1.1	Y90S-4
		2	2800	582	524		
		3	3080	586	517		
		4	3360	571	488		
		5	3640	542	444		
		6	3920	504	390		

拒绝虚假



DTJ 系列

DTJ10-I 性能曲线图

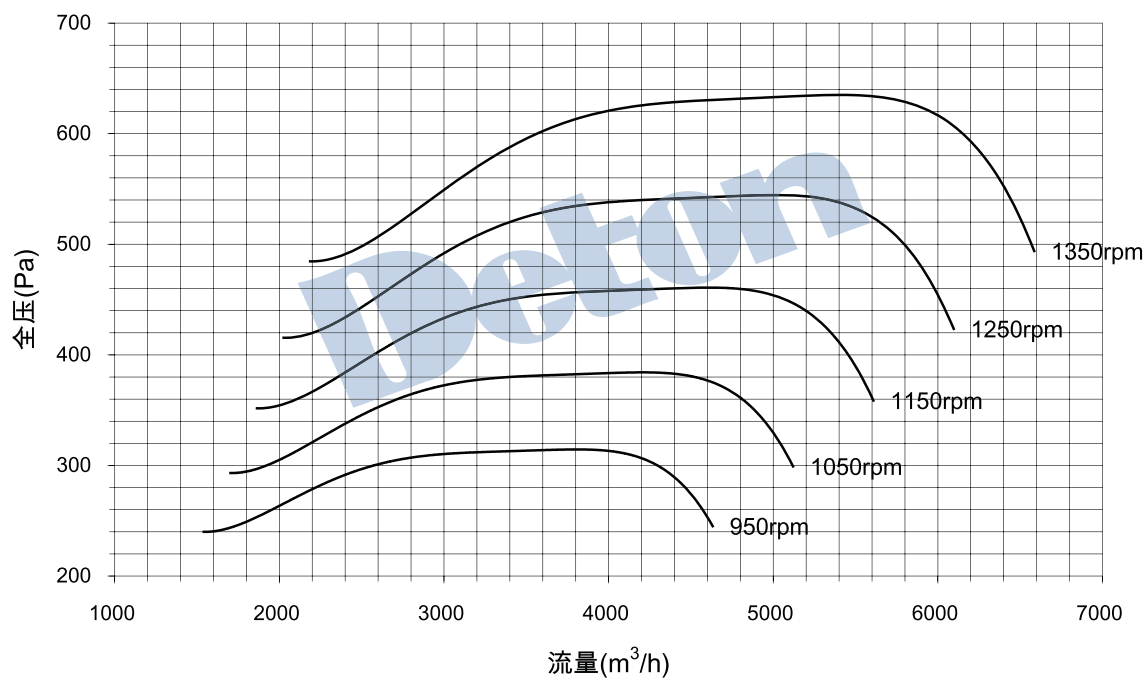

DTJ10-I 性能参数表

序号	转速 (r/min)	工况点序号 (No)	风量 (m³/h)	全压 (pa)	静压 (pa)	电机功率 (kw)	电机型号
1	950	1	2280	284	258	0.75	Y80 ₂ -4
		2	2850	308	268		
		3	3420	313	255		
		4	3800	315	243		
		5	4180	308	221		
		6	4636	244	137		
2	1050	1	2520	347	316	1.1	Y90S-4
		2	3150	376	327		
		3	3780	382	311		
		4	4200	384	297		
		5	4620	376	270		
		6	5124	298	168		
3	1150	1	2760	416	378	1.5	Y90L-4
		2	3450	452	392		
		3	4140	459	373		
		4	4600	461	356		
		5	5060	451	324		
		6	5612	358	201		
4	1250	1	3000	492	447	1.5	Y90L-4
		2	3750	533	464		
		3	4500	542	441		
		4	5000	545	420	2.2	Y100L ₁ -4
		5	5500	533	382		
		6	6100	423	238		
5	1350	1	3240	574	522	2.2	Y100L ₁ -4
		2	4050	622	541		
		3	4860	632	515		
		4	5400	635	490		
		5	5940	621	446		
		6	6588	493	277		



参数实测

DTJ12-I 性能曲线图

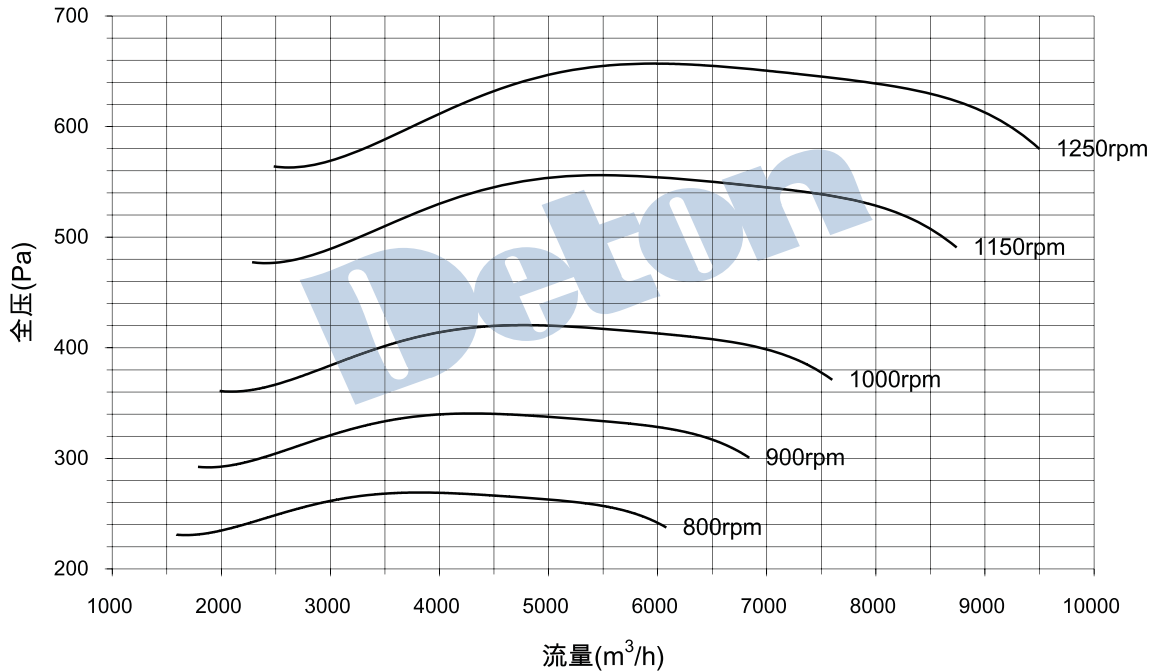

DTJ12-I 性能参数表

序号	转速 (r/min)	工况点序号 (No)	风量 (m³/h)	全压 (pa)	静压 (pa)	电机功率 (kW)	电机型号
1	800	1	2400	246	232	0.75	Y80 ₂ -4
		2	3200	265	239		
		3	4000	269	229		
		4	4800	264	207		
		5	5440	258	184		
		6	6080	237	145		
2	900	1	2700	311	293	1.1	Y90S-4
		2	3600	335	303		
		3	4500	340	290		
		4	5400	335	262		
		5	6120	326	232		
		6	6840	301	184		
3	1000	1	3000	384	362	1.5	Y90L-4
		2	4000	414	374		
		3	5000	420	358		
		4	6000	413	323		
		5	6800	403	287		
		6	7600	371	227		
4	1150	1	3450	508	479	2.2	Y100L ₁ -4
		2	4600	548	495		
		3	5750	555	473		
		4	6900	546	427		
		5	7820	533	380		
		6	8740	491	300		
5	1250	1	3750	600	566	3	Y100L ₂ -4
		2	5000	647	584		
		3	6250	656	559		
		4	7500	645	505		
		5	8500	630	448		
		6	9500	580	355		

拒绝虚假



DTJ 系列

DTJ15-I 性能曲线图

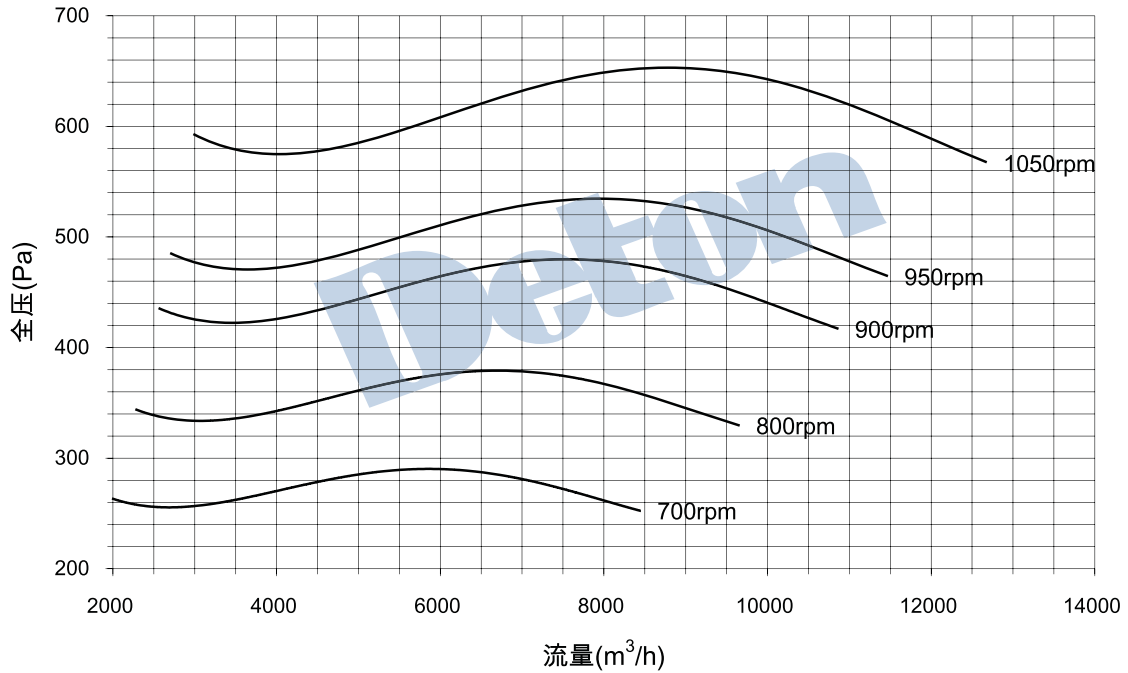

DTJ15-I 性能参数表

序号	转速 (r/min)	工况点序号 (No)	风量 (m³/h)	全压 (pa)	静压 (pa)	电机功率 (kw)	电机型号
1	700	1	3465	260	244	1.5	Y90L-4
		2	4506	282	256		
		3	5338	288	251		
		4	6290	286	235		
		5	7679	271	194		
		6	8400	252	160		
2	800	1	3960	339	318	2.2	Y100L ₁ -4
		2	5150	368	334		
		3	6101	376	328		
		4	7189	374	307		
		5	8776	354	254		
		6	9600	329	209		
3	900	1	4455	429	403	3	Y100L ₂ -4
		2	5793	466	422		
		3	6864	476	416		
		4	8087	473	388		
		5	9873	448	321		
		6	10800	417	264		
4	950	1	4703	478	449	4	Y112M-4
		2	6115	519	471		
		3	7245	531	463		
		4	8536	527	432		
		5	10422	499	358		
		6	11400	464	295		
5	1050	1	5198	584	548	5.5	Y132S-4
		2	6759	634	575		
		3	8008	648	566		
		4	9435	644	528		
		5	11519	609	438		
		6	12600	567	360		



参数实测

DTJ18-I 性能曲线图

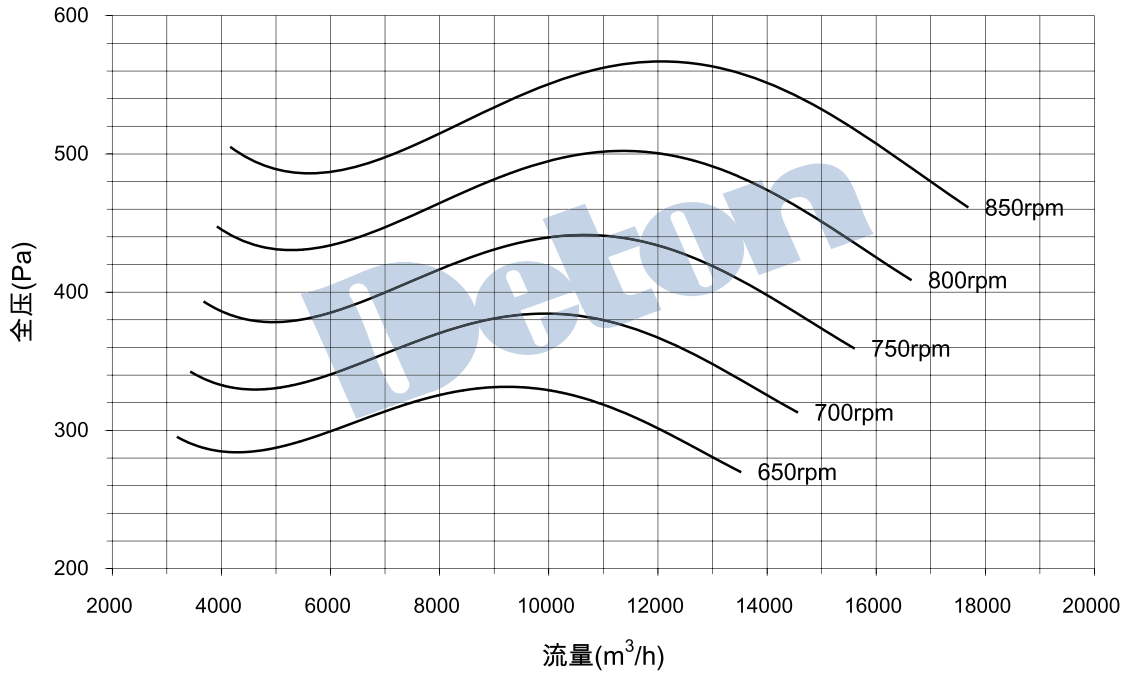

DTJ18-I 性能参数表

序号	转速 (r/min)	工况点序号 (No)	风量 (m³/h)	全压 (pa)	静压 (pa)	电机功率 (kW)	电机型号		
1	650	1	5545	292	272	2.2	Y100L ₁ -4		
		2	7211	319	285				
		3	8543	328	280				
		4	10066	328	262				
		5	12290	296	198				
		6	13000	280	169				
2	700	1	5972	339	315	3	Y100L ₂ -4		
		2	7766	370	331				
		3	9201	381	325				
		4	10841	381	304				
		5	13235	344	229				
		6	14000	325	196				
3	750	1	6398	389	362	3	Y100L ₂ -4		
		2	8320	425	380				
		3	9858	437	373				
		4	4	4	11615	437	349	4	Y112M-4
				5	14180	395	263		
				6	15000	373	225		
4	800	1	6825	442	412	4	Y112M-4		
		2	8875	483	432				
		3	10515	497	425				
		4	12389	497	397				
		5	15126	449	299				
		6	16000	424	256				
5	850	1	7252	499	465	5.5	Y132S-4		
		2	9430	546	487				
		3	11172	561	480				
		4	13164	561	448				
		5	16071	507	338				
		6	17000	479	289				

拒绝虚假



DTJ 系列

DTJ20-I 性能曲线图

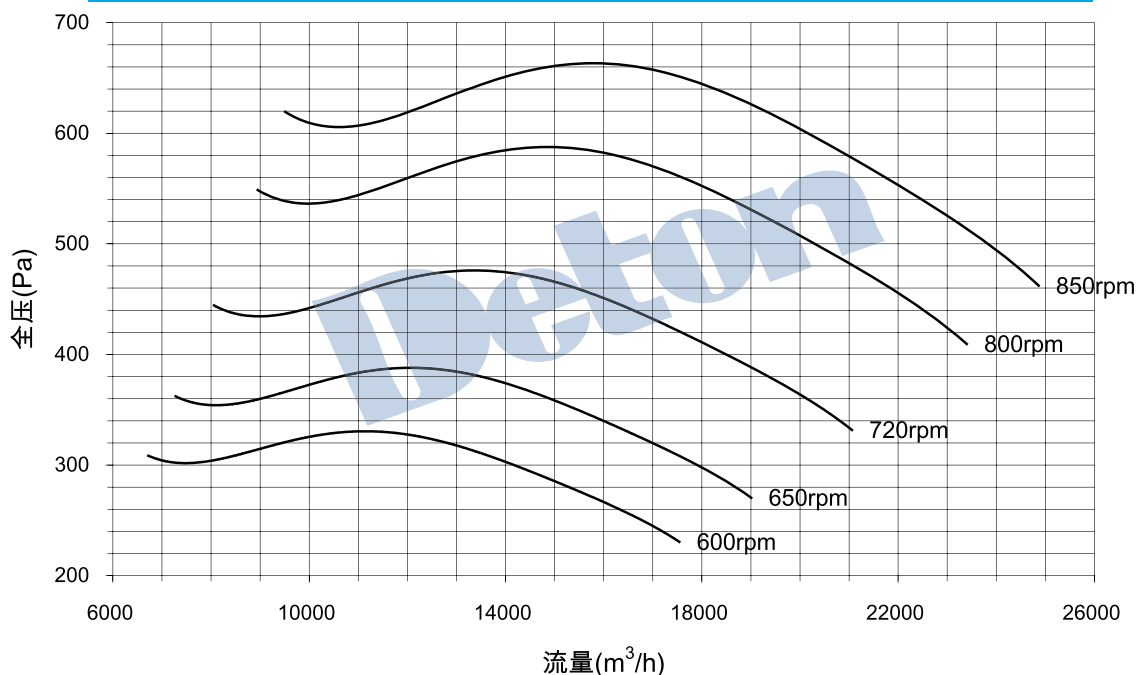

DTJ20-I 性能参数表

序号	转速 (r/min)	工况点序号 (No)	风量 (m³/h)	全压 (pa)	静压 (pa)	电机功率 (kw)	电机型号
1	600	1	7630	301	285	2.2	Y100L ₁ -4
		2	9403	320	295		
		3	11463	329	292		
		4	13976	304	248	3	
		5	15789	270	199		
		6	17000	245	162		
2	650	1	8266	354	334	3	Y100L ₂ -4
		2	10186	376	346		
		3	12418	387	342		
		4	15141	357	291	4	
		5	17104	317	233		
		6	18417	288	190		
3	720	1	9156	434	410	4	Y112M-4
		2	11283	461	424		
		3	13755	474	420		
		4	16771	438	357	5.5	
		5	18946	389	286		
		6	20400	353	233		
4	800	1	10173	536	506	5.5	Y132S-4
		2	12537	569	524		
		3	15283	586	518		
		4	18635	540	440	7.5	
		5	21051	481	353		
		6	22667	436	288		
5	850	1	10809	605	571	7.5	Y132M-4
		2	13321	643	592		
		3	16239	661	585		
		4	19799	610	497		
		5	22367	543	399		



参数实测

DTJ22-I 性能曲线图

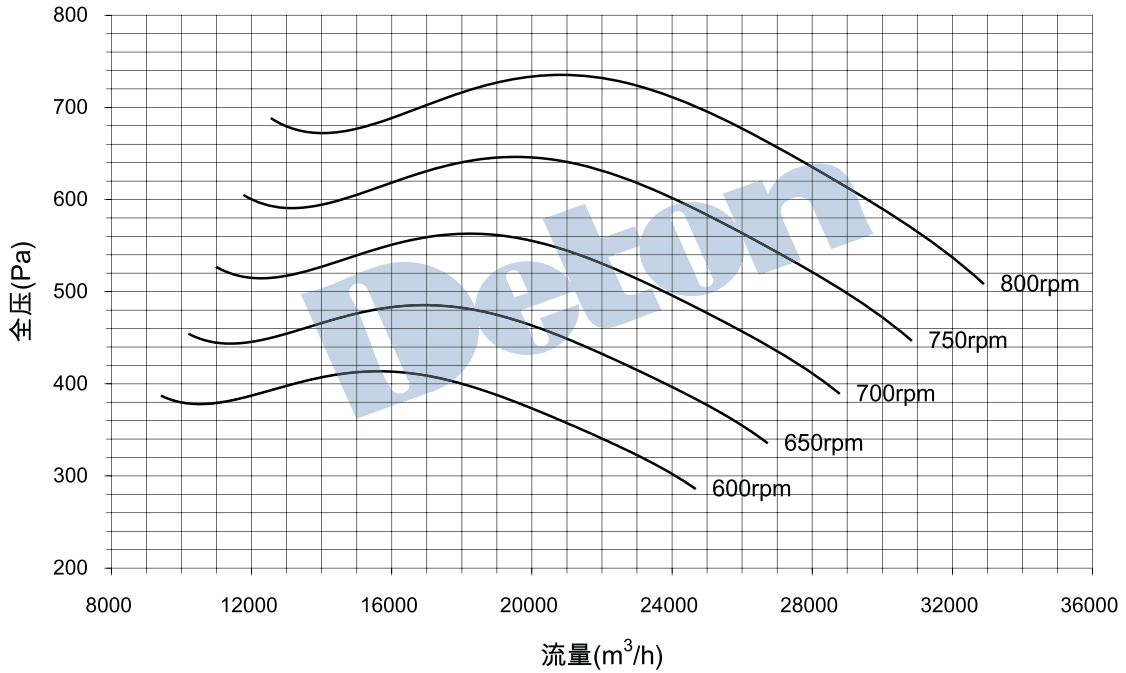

DTJ22-I 性能参数表

序号	转速 (r/min)	工况点序号 (No)	风量 (m³/h)	全压 (pa)	静压 (pa)	电机功率 (kW)	电机型号
1	600	1	10719	378	357	4	Y112M-4
		2	13210	401	370		
		3	16104	412	366		
		4	19635	379	311	5.5	
		5	22182	337	249		
		6	24677	286	177		
2	650	1	11612	443	419	5.5	Y132S-4
		2	14311	471	434		
		3	17446	484	429		
		4	21272	445	364	7.5	
		5	24030	396	292		
		6	26733	335	208		
3	700	1	12506	514	486	7.5	Y132M-4
		2	15412	546	503		
		3	18788	561	498		
		4	22908	516	423		
		5	25879	459	339		
		6	28789	389	241		
4	750	1	13399	590	558	7.5	Y132M-4
		2	16513	627	578		
		3	20130	644	571		
		4	24544	593	485	11	
		5	27727	527	389		
		6	30846	447	277		
5	800	1	14292	671	635	11	Y160M-4
		2	17614	713	657		
		3	21472	733	650		
		4	26181	675	552		
		5	29576	599	443		

DTJ25-I 性能曲线图

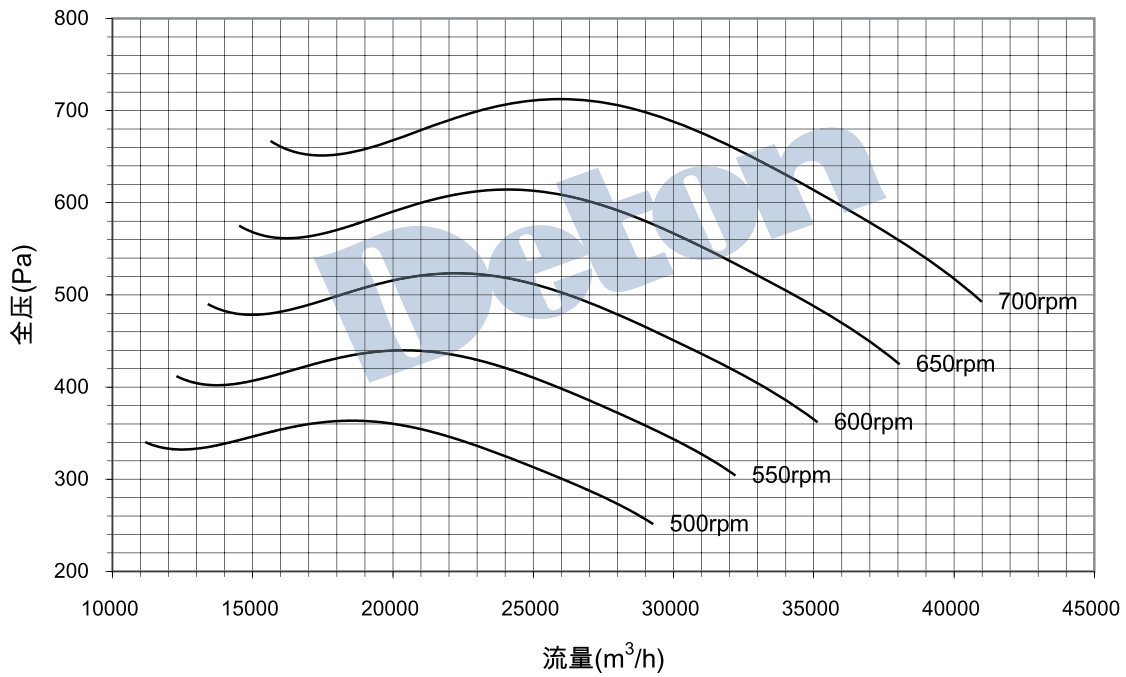

DTJ25-I 性能参数表

序号	转速 (r/min)	工况点序号 (No)	风量 (m ³ /h)	全压 (pa)	静压 (pa)	电机功率 (kw)	电机型号
1	500	1	12719	332	314	4	Y112M-4
		2	15674	352	325		
		3	19108	362	321		
		4	23298	334	273	5.5	
		5	26319	296	219		
		6	28500	265	174		
2	550	1	13990	402	380	5.5	Y132S-4
		2	17242	426	393		
		3	21019	438	389		
		4	25628	404	330	7.5	
		5	28951	359	265		
		6	31350	321	211		
3	600	1	15262	478	452	7.5	Y132M-4
		2	18809	507	468		
		3	22929	522	463		
		4	27957	480	393	11	
		5	31583	427	315		
		6	34200	382	251		
4	650	1	16534	561	530	11	Y160M-4
		2	20377	596	549		
		3	24840	612	543		
		4	30287	564	461		
		5	34215	501	370		
		6	37050	448	294		
5	700	1	17806	650	615	11	Y160M-4
		2	21944	691	637		
		3	26751	710	630		
		4	32617	654	535	15	
		5	36847	581	429		
		6	39900	519	341		



参数实测

DTJ28-I 性能曲线图

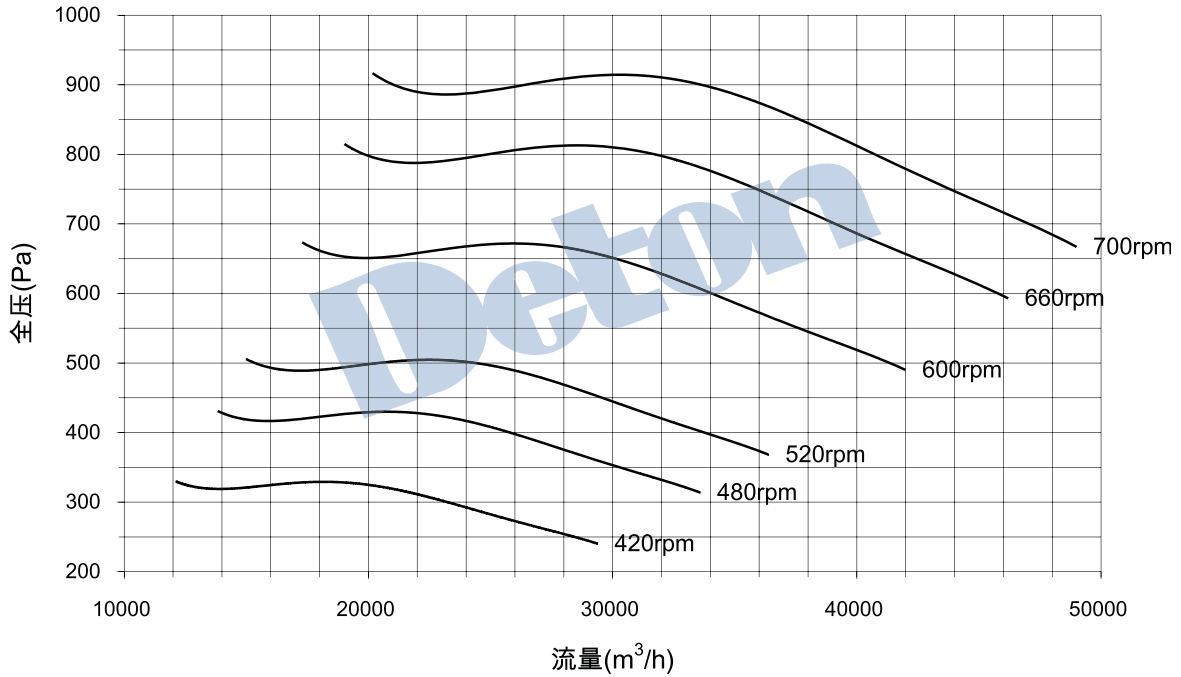

DTJ28-I 性能参数表

序号	转速 (r/min)	工况点序号 (No)	风量 (m³/h)	全压 (pa)	静压 (pa)	电机功率 (kw)	电机型号
1	420	1	16100	325	296	4	Y132M ₁ -6
		2	18200	329	292		
		3	21000	319	270		
		4	23800	294	231		
		5	26600	267	188		
		6	29400	240	144		
2	480	1	18500	425	386	5.5	Y132S-4
		2	21000	430	381		
		3	24000	417	352		
		4	27000	387	306		
		5	30000	353	253		
		6	33500	315	190		
3	520	1	20000	498	454	7.5	Y132M-4
		2	23000	504	445		
		3	26000	489	414		
		4	29500	451	354		
		5	33000	408	287		
		6	36500	367	218		
4	600	1	23000	663	604	11	Y160M-4
		2	26000	672	596		
		3	30000	651	551		
		4	34000	601	472		
		5	38000	545	384		
		6	42000	490	293		
5	660	1	25000	800	730	15	Y160L-4
		2	29000	813	719		
		3	33000	788	666		
		4	37000	734	581		
		5	41000	672	484		
		6	45000	612	386		
6	700	1	27000	903	822	18.5	Y180M-4
		2	31000	914	806		
		3	35000	886	750		
		4	40000	813	635		
		5	44000	747	531		
		6	48000	684	426		

DTJ30-I 性能曲线图

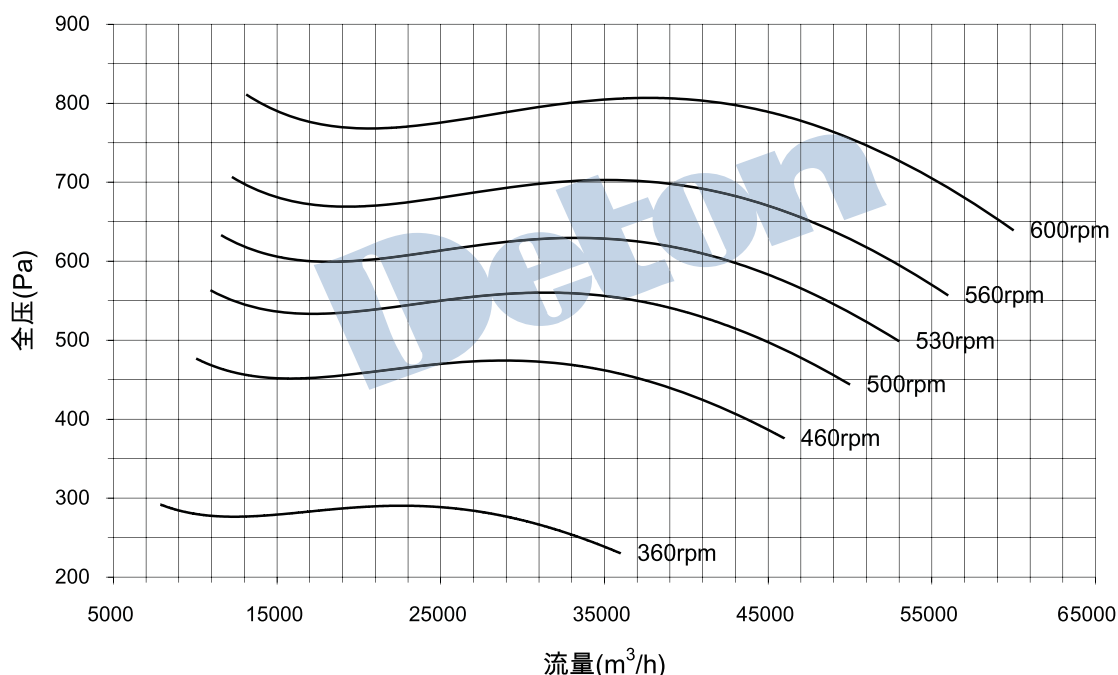

DTJ30-I 性能参数表

序号	转速 (r/min)	工况点序号 (No)	风量 (m³/h)	全压 (pa)	静压 (pa)	电机功率 (kw)	电机型号
1	360	1	20160	289	256	7.5	Y160M-6
		2	23040	290	247		
		3	25200	288	237		
		4	27360	283	222		
		5	30240	271	196		
		6	33120	253	164		
2	460	1	26000	472	417	11	Y160M-4
		2	30000	474	400		
		3	33000	469	380		
		4	36000	457	352		
		5	40000	432	303		
		6	44000	397	240		
3	500	1	28000	557	494	11	Y160M-4
		2	32000	560	477		
		3	35000	556	457		
		4	38000	546	429		
		5	42000	522	379		
		6	46000	488	317		
4	530	1	30000	626	554	15	Y160L-4
		2	34000	629	536		
		3	38000	622	505		
		4	42000	604	461		
		5	46000	574	403		
		6	50000	535	333		
5	560	1	32000	700	617	18.5	Y180M-4
		2	36000	703	598		
		3	40000	695	566		
		4	45000	670	506		
		5	49000	637	443		
		6	53000	595	368		
6	600	1	35000	805	706	18.5	Y180M-4
		2	40000	805	676		
		3	44000	794	637		
		4	48000	770	585		
		5	52000	737	518		
		6	56000	693	439		



参数实测

DTJ-II 双速风机性能参数 (表一)

序号	转速 (r/min)	工况点序号 (No)	风量 (m ³ /h)	全压 (pa)	静压 (pa)	电机功率 (kw)	电机型号
DTJ15	1050	1	5198	584	548	4.7/1.5	YDT132S-4/6
		2	8008	648	566		
		3	11519	609	438		
	700	1	3465	260	244		
		2	5338	288	251		
		3	7679	271	194		
DTJ15	1000	1	4950	530	497	4.5/2.2	YDT132M ₂ -6/8
		2	7626	588	513		
		3	10970	553	397		
	750	1	3713	298	280		
		2	5720	331	289		
		3	8228	311	223		
DTJ18	850	1	7252	499	465	4.7/1.5	YDT132S-4/6
		2	11172	561	480		
		3	16071	507	338		
	570	1	4863	225	209		
		2	7492	252	216		
		3	10777	228	152		
DTJ18	850	1	7252	499	465	4.5/2.2	YDT132M ₂ -6/8
		2	11172	561	480		
		3	16071	507	338		
	640	1	5460	283	264		
		2	8412	318	272		
		3	12100	287	192		
DTJ20	800	1	10173	536	506	6.7/2.2	YDT132M-4/6
		2	15283	586	518		
		3	21051	481	353		
	540	1	6867	244	231		
		2	10316	267	236		
		3	14210	219	161		
DTJ20	800	1	10173	536	506	6.5/3.2	YDT160M-6/8
		2	15283	586	518		
		3	21051	481	353		
	600	1	7630	301	285		
		2	11463	329	292		
		3	15789	270	199		
DTJ22	750	1	13399	590	558	9.5/3.1	YDT160M-4/6
		2	20130	644	571		
		3	27727	527	389		
	500	1	8933	262	248		
		2	13420	286	254		
		3	18485	234	173		

拒绝虚假



DTJ 系列

DTJ-II 双速风机性能参数 (表二)

序号	转速 (r/min)	工况点序号 (No)	风量 (m ³ /h)	全压 (pa)	静压 (pa)	电机功率 (kw)	电机型号
DTJ22	720	1	12863	544	514	9/4.5	YDT160L-6/8
		2	19325	593	527		
		3	26618	485	359		
	540	1	9647	306	289		
		2	14494	334	296		
		3	19964	273	202		
DTJ25	650	1	20377	596	549	12/4	YDT160L-4/6
		2	30287	564	461		
		3	37050	448	294		
	430	1	13480	261	240		
		2	20036	247	202		
		3	24510	196	129		
DTJ25	650	1	20377	596	549	13/6.5	YDT180L-6/8
		2	30287	564	461		
		3	37050	448	294		
	490	1	15361	338	312		
		2	22832	320	262		
		3	27930	255	167		
DTJ28	660	1	29000	813	719	15.5/5.1	YDT180M-4/6
		2	37000	734	581		
		3	45000	612	386		
	440	1	19250	361	320		
		2	24750	325	257		
		3	30000	272	172		
DTJ28	620	1	27125	717	635	13/6.5	YDT180L-6/8
		2	34875	645	510		
		3	42273	540	341		
	460	1	20125	395	350		
		2	25875	355	281		
		3	31364	297	188		
DTJ30	600	1	35000	805	706	18/6.2	YDT180L-4/6
		2	44000	794	637		
		3	52000	737	518		
	400	1	24000	358	312		
		2	30000	351	278		
		3	36000	318	213		
DTJ30	530	1	31800	629	548	13/6.5	YDT180L-6/8
		2	39750	616	488		
		3	47700	558	374		
	400	1	24000	358	312		
		2	30000	351	278		
		3	36000	318	213		

DTJ 系列外形安装尺寸示意图

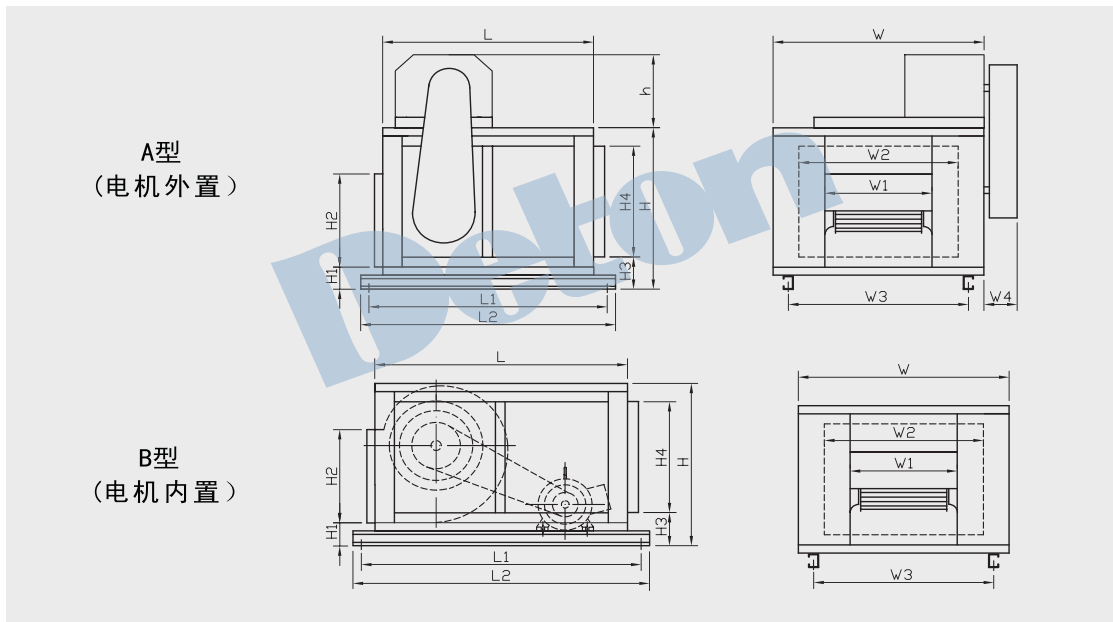

外型尺寸表

单位：mm

机号	外形尺寸				进风口		出风口		地脚孔尺寸		辅助尺寸					重量 (kg)		
	长 L		宽 W	高 H	横 W2	竖 H4	横 W1	竖 H2	L1		W3	L2		W4	H1	H3	A 型	B 型
	A 型	B 型							A 型	B 型		A 型	B 型					
9"	650	850	680	550	538	370	298	262	750	950	570	810	1010	90	121	130	78.7	86
10"	700	950	750	605	608	426	331	289	800	1050	641	860	1110	90	121	130	95	103
12"	760	1000	880	685	738	504	395	341	860	1100	769	920	1160	110	121	130	114	123
15"	870	1140	980	770	778	592	471	404	970	1240	865	1030	1300	110	121	130	120	143
18"	1000	1160	1160	915	956	733	560	481	1120	1280	1040	1200	1360	110	128	130	155	193
20"	1100	1320	1320	1075	1117	893	635	630	1220	1440	1172	1300	1520	110	121	130	308	358
22"	1220	1400	1400	1195	1197	1013	715	712	1340	1520	1280	1420	1600	110	128	130	342	398
25"	1360	1520	1520	1320	1215	1140	805	803	1480	1640	1400	1560	1720	140	130	130	380	420
28"	1450	1700	1700	1460	1397	1280	905	902	1570	1820	1535	1650	1900	140	128	130	475	530
30"	1590	1820	1820	1510	1517	1330	918	825	1730	1960	1656	1790	2010	140	130	130	585	635

说明

- 1、上表中重量数据不包含电机重量，风机总重量等于上表中所示重量加上配用电机的重量。电机重量数据可参见第 56 页电机参数表中查得。
- 2、A 型风机总高度=风柜高H+配用电机罩高度h。配用电机罩高度h可参见第 56 页电机参数表中查得。
- 3、图中所示是（1）号风口方向的安装尺寸，其它风口方向的安装尺寸需另外提供。
- 4、图中地脚孔尺寸仅供参考，不能作为精确定位用。

拒绝虚假



DTJ 系列

电机参数表

电机型号	Y80 ₁ -4	Y80 ₂ -4	Y90S-4	Y90L-4	Y100L ₁ -4	Y100L ₂ -4		Y112M-4		
电机功率 (kW)	0.55	0.75	1.1	1.5	2.2	3		4		
电机重量 (kg)	17	18	22	27	33	38		49		
配用电机罩高度 h (mm)	310	310	310	310	9" ~ 18"	20" ~ 30"	9" ~ 18"	20" ~ 30"	9" ~ 18"	20" ~ 30"
					380	420	380	420	380	420

电机型号	Y132S-4		Y132M-4		Y160M-4	Y160L-4	Y180M-4	Y180L-4
电机功率 (kW)	5.5		7.5		11	15	18.5	22
电机重量 (kg)	67		80		126	139	180	198
配用电机罩高度 h (mm)	9" ~ 18"	20" ~ 30"	9" ~ 18"	20" ~ 30"	525	525	575	575
	425	470	425	470				